

*D<sub>8</sub>*

Restorative / Stomatologia zachowawcza



# Compo-fill Instruments

Easy  
**COLOR**



Ultra Light weight  
Non-stick tips  
TIN coated

Bardzo lekkie  
Końcówki "Non-Stick"  
Pokryte azotkiem tytanu



135° C  
Autoclavable  
Możliwość sterylizacji w autoklawie

Silicone handle with Aluminum core  
Uchwyt silikonowy z rdzeniem aluminiowym

## Pluggers / Przenośniki



Fig. 5A DR.051.051



Fig. 3 DR.073.031 Hollenback



Fig. 1 DR.091.011 Super



Fig. OT DR.092.001 Tanner



Fig. 0/1 DR.063.011 Black



Fig. 1/2 DR.063.021 Black

## Burnishers / Upychadła



Fig. 21B DR.111.211 Acorn/ Wescott



Fig. 1 DR.121.011 Contact Former



Fig. 2 DR.121.021 Contact Former



Fig. 2 DR.139.021 Ladmore



Fig. 3 DR.139.031 Ladmore



Fig. 27/29 DR.148.041 White



Fig. 1 DR.100.011



Fig. 1L DR.101.011



Fig. 155 DR.135.551

Filling instruments / Nakładacze



Autoclavable  
Możliwość sterylizacji w autoklawie

Easy  
COLOR



Fig. 156(A6) DR.426.561



Fig. 8A DR.431.081



Fig. 1 DR.445.011 Boghosian



Fig. 2 DR.445.021 Boghosian



Fig. 1 DR.451.011 Falcon



Fig. 2 DR.451.021 Falcon



Fig. 1 DR.457.011 Goldstein



Fig. 2 DR.457.021 Goldstein



Fig. 3 DR.457.031 Goldstein



Fig. 4 DR.457.041 Goldstein



Fig. 1 DR.458.011 Goldstein-Mini



Fig. 3 DR.458.031 Goldstein-Mini



Fig. 4 DR.458.041 Goldstein-Mini



Fig. 1 DR.459.011 Goldstein-Micro



Fig. 4/5 DR.460.051 Gregg



Fig. 0 DR.463.001 Heidemann



Fig. 1 DR.463.011 Heidemann



Fig. 2 DR.463.021 Heidemann



Fig. W3 DR.513.031



Fig. 1 DR.425.011



Fig. 6 DR.425.061



Fig. 178 DR.426.781



Fig. 49 DR.440.491

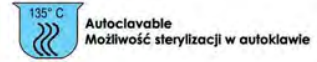

Fig. 179 DR.440.791



# Restorative Stomatologia zachowawcza

Compo-fill Instruments TIN coated  
Compo-fill Instrumenty pokryte azotkiem tytanu



## Pluggers / Przenośniki



Fig. 1/2 DR.063.025T Black



Fig. 1 DR.091.015T Super



Fig. 3 DR.073.035T Hollenback



Fig. 0T DR.092.005T Tanner

## Burnishers / Upychadła



Fig. 21B DR.111.215T Acorn/ Wescott



Fig. 3 DR.139.035T Ladmore



Fig. 1 DR.121.015T Contact former



Fig. 27/29 DR.148.045T White

## Filling Instruments / Nakładacze



Fig. 1 DR.425.015T



Fig. 1 DR.457.015T Goldstein



Fig. 6 DR.425.065T



Fig. 2 DR.457.025T Goldstein



Fig. 156 (A6) DR.426.565T



Fig. 4 DR.458.045T Goldstein-mini



Fig. 178 DR.426.785T



Fig. 4/5 DR.460.055T Gregg



Fig. 49 DR.440.495T



Fig. 2 DR.463.025T Heidemann



Fig. 2 DR.451.025T Falcon



Fig. W3 DR.513.035T



TIN coated / Pokryte azotkiem tytanu

135° C Autoclavable  
Możliwość sterylizacji w autoklawie

Burnishers / Upychadła

Classic Round

6 mm solid handle  
6 mm pełny uchwyt



Acorn / Wescott



Fig. 21 DR.110.210T



Fig. 21B DR.111.210T

Falcon



Fig. 1 DR.130.010T



Fig. 2 DR.130.020T

Falcon



Fig. 3 DR.130.030T



Fig. 4 DR.130.040T



Fig. 5 DR.130.050T

White



Fig. 27/29 DR.148.040T

Super



Fig. 1 DR.091.010T

135° C Autoclavable  
Możliwość sterylizacji w autoklawie

Filling instruments / Nakładacze

Classic Round

6 mm solid handle  
6 mm pełny uchwyt



Falcon



Fig. 0 DR.452.000T

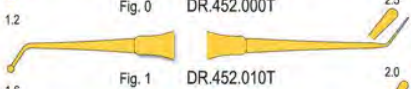

Fig. 1 DR.452.010T



Fig. 2 DR.452.020T



Fig. 3 DR.452.030T



Fig. 4 DR.452.040T



Fig. 5 DR.452.050T

Falcon



Fig. 6 DR.452.060T



Fig. 7 DR.452.070T



Fig. 8 DR.452.080T



Fig. 9 DR.452.090T



Fig. 10 DR.452.100T

Falcon

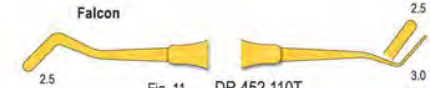

Fig. 11 DR.452.110T



Fig. 12 DR.452.120T

Heidemann



Fig. 0 DR.463.000T



Fig. 1 DR.463.010T



Fig. 2 DR.463.020T

135° C Autoclavable  
Możliwość sterylizacji w autoklawie

Plastic amalgam carriers / Pistolet do amalgamatu plastikowe



PP011/0041  
Right angled  
Zagięty pod kątem

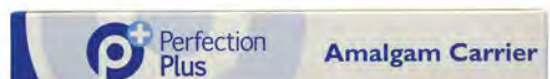

PP011/004  
Curved  
Zagięty



**Amalgam carriers / Pistolety do amalgamatu**

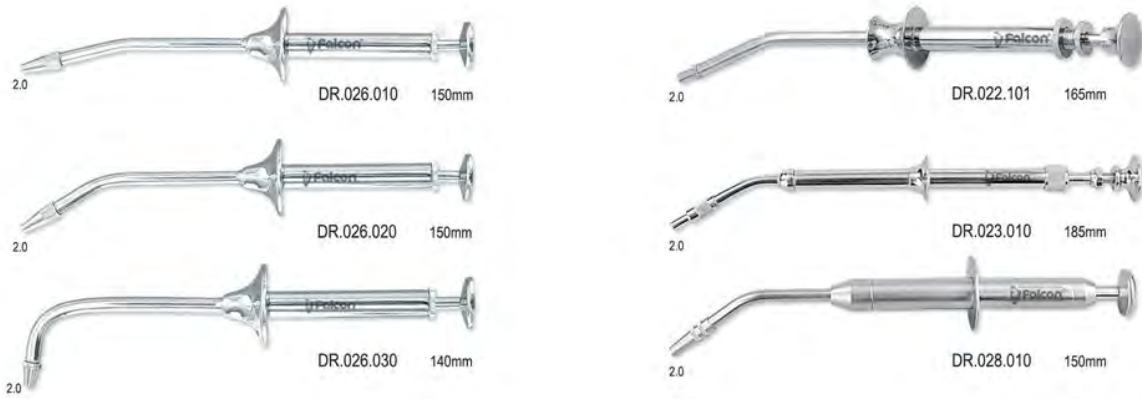

**Amalgam guns / Pistolety do amalgamatu**



Amalgam well / Miska do amalgamatu



DR.098.010  
Autoclavable  
Możliwość sterylizacji w autoklawie

Amalgam gun for micro filling  
Pistolet do amalgamatu do mikro wypełnień



Ø 1.2 mm  
DR.024.020 Straight / Prosty  
DR.024.030 Curved / Zagięty  
130 mm

Pluggers  
Przeñośniki



**SOFT LINE INSTRUMENTS**  
soft and sure grip

135° C Autoclavable  
Możliwość sterylizacji w autoklawie

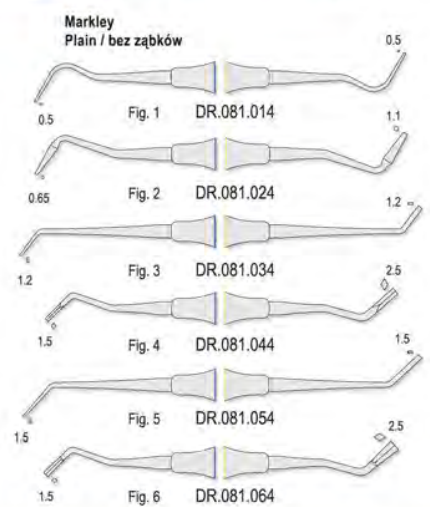
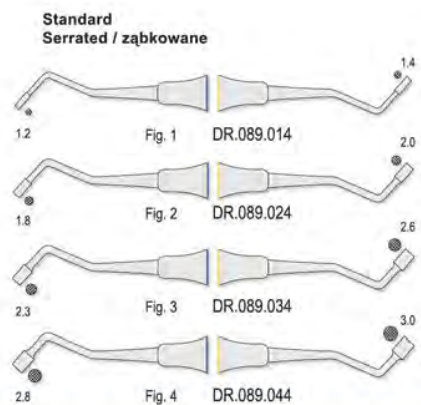
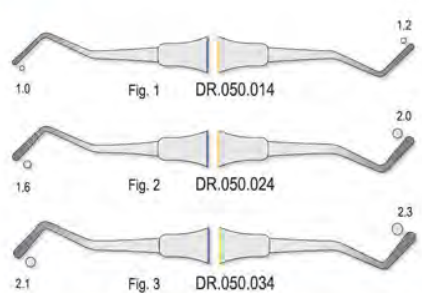

Super plugger / Przeñośnik Super



Fig.1 DR.091.014

Pluggers / Przeñośniki

**Classic-8**  
5.5 mm solid handle  
5.5 mm pełny uchwyt

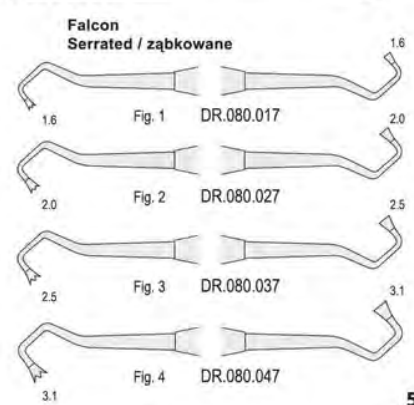
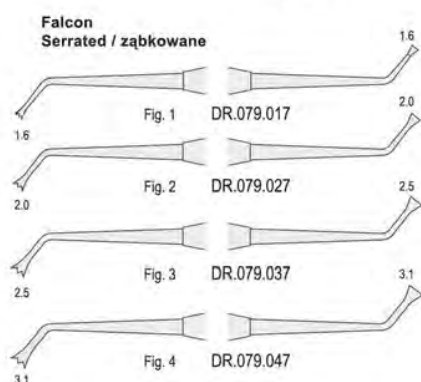
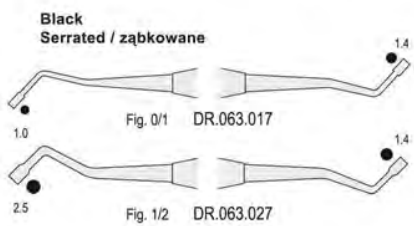



**Pluggers / Przenośniki**

**Classic Round**

6 mm solid handle  
6 mm pełny uchwyt

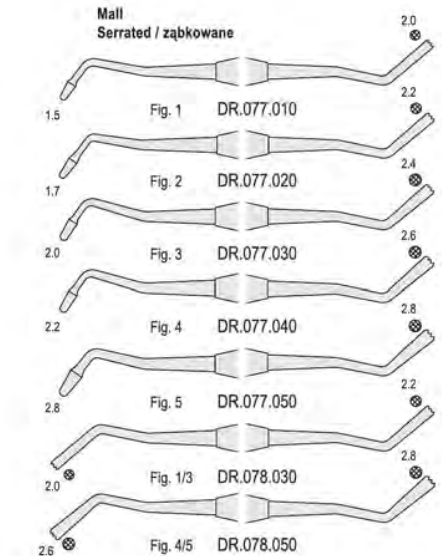
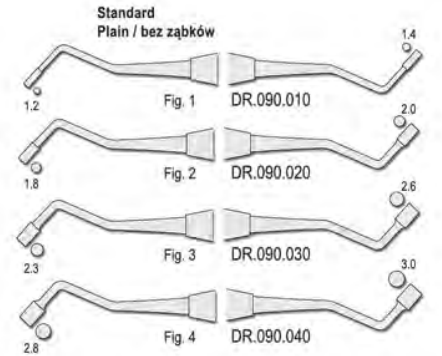
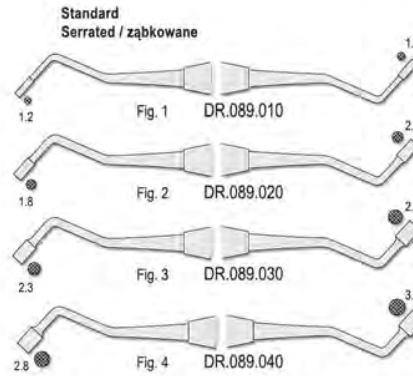
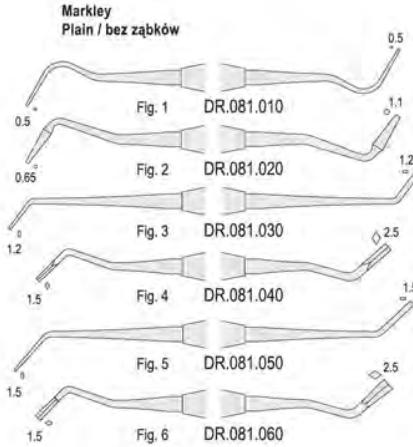
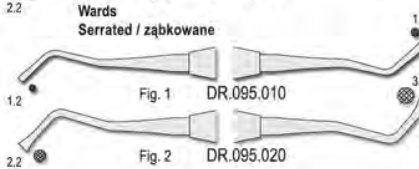
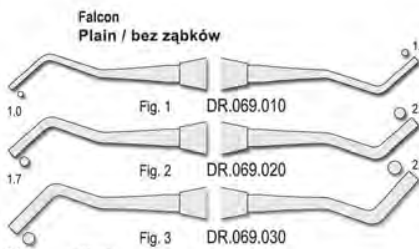
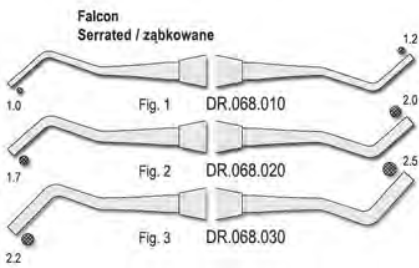
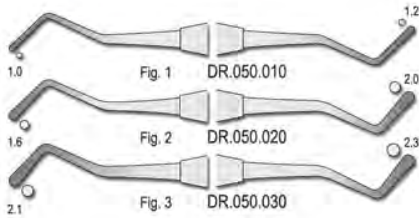

**Burnishers / Upychadła**

**SOFT LINE INSTRUMENTS**  
soft and sure grip

135°C Autoclavable  
Możliwość sterylizacji w autoklawie

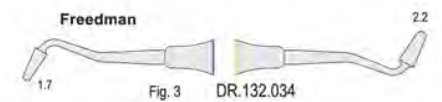
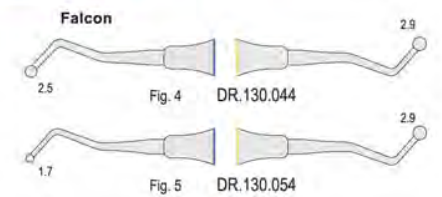
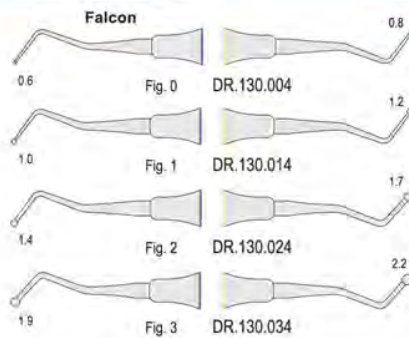
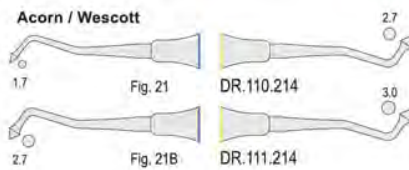



Burnishers / Upychadła



10 mm hollow handle  
10 mm pusty uchwyt



Acorn / Wescott

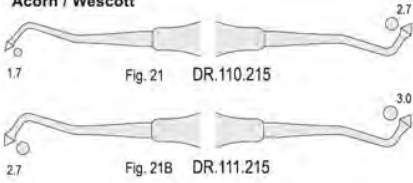

Falcon

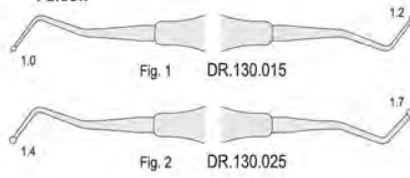

Falcon

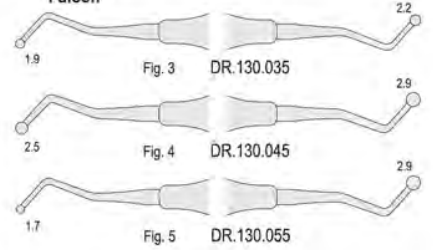

White

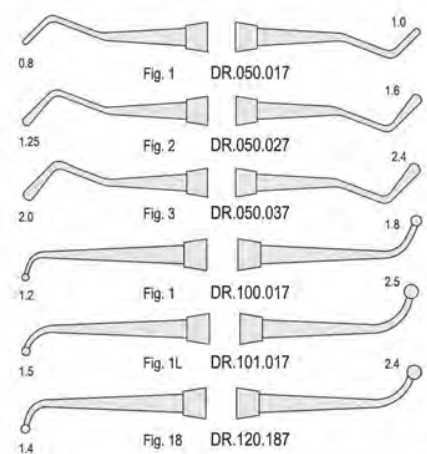
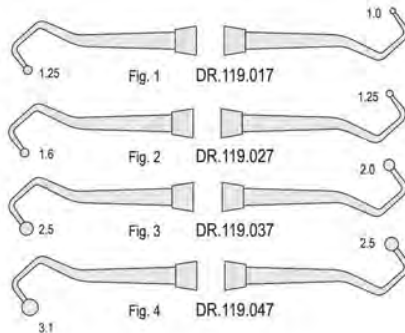
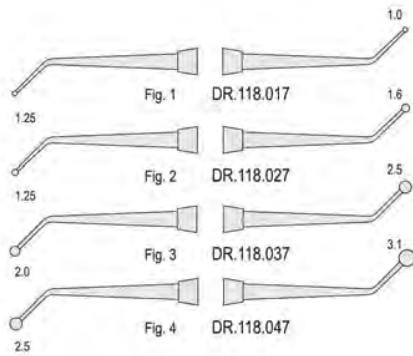

Fig. 27/29 DR.148.045

Burnishers / Upychadła



5.5 mm solid handle  
5.5 mm pełny uchwyt



Burnishers / Upychadła



6 mm solid handle  
6 mm pełny uchwyt



Acorn / Wescott

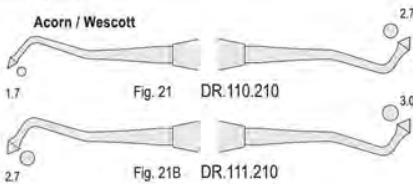

Ladmore

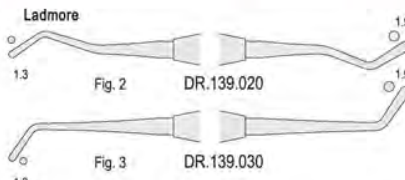

Falcon

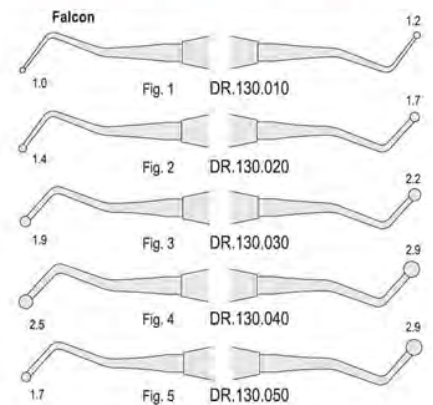

Beavertail / White

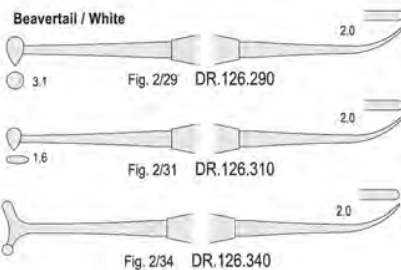

White

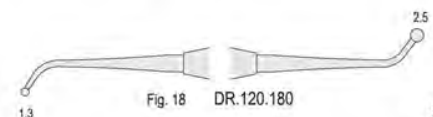
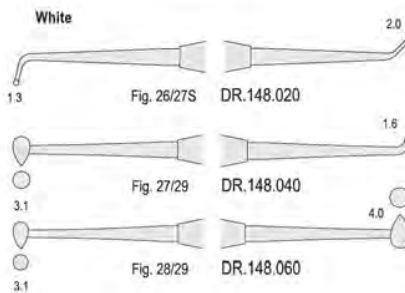



**Filling instruments  
Nakładacze**



Autoclavable  
Możliwość sterylizacji w autoklawie

**SOFT LINE INSTRUMENTS**  
soft and sure grip

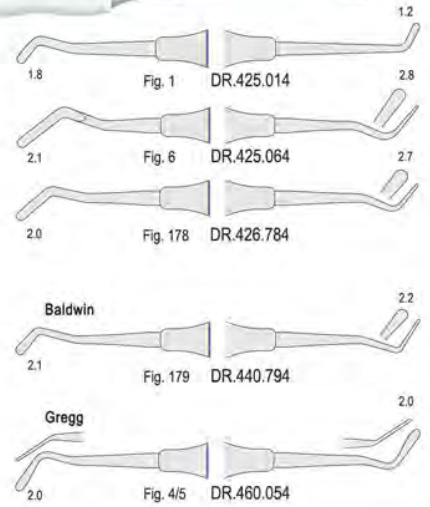
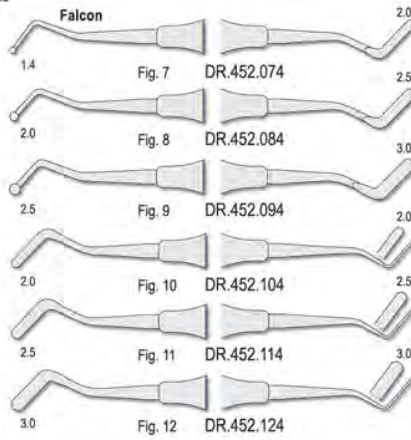
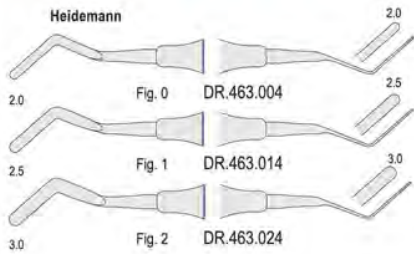

**Filling instruments  
Nakładacze**

**Classic-8**  
5.5 mm solid handle  
5.5 mm pełny uchwyt

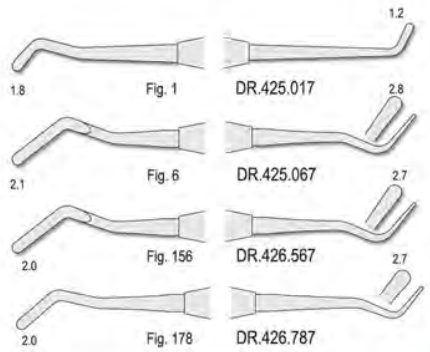
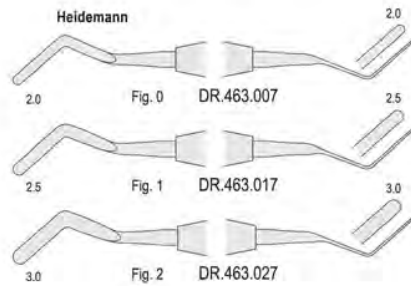
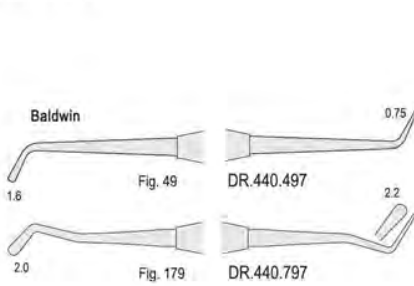

**Filling instruments  
Nakładacze**

**CLASSIC-LITE**  
10 mm hollow handle  
10 mm pusty uchwyt

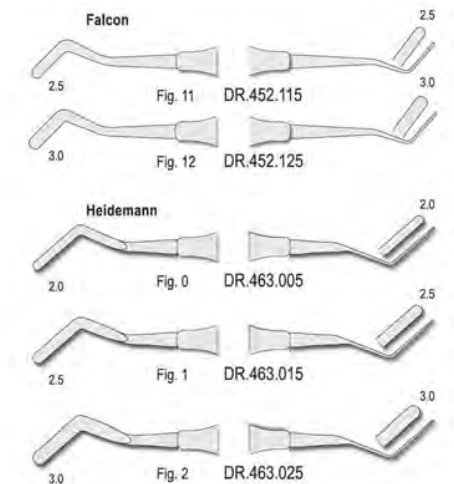
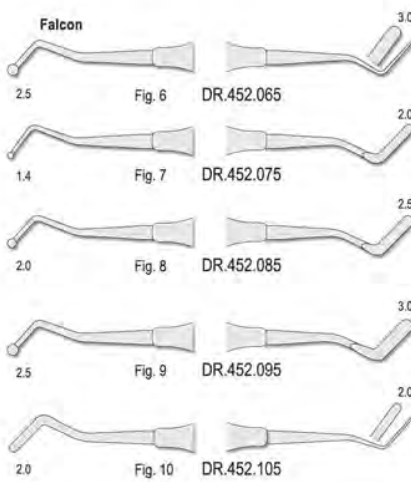
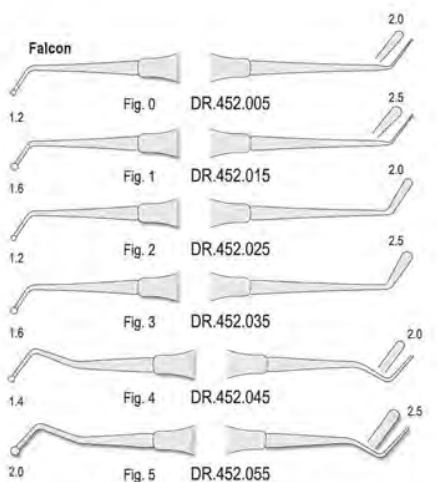

Filling instruments  
Nakładacze

**Classic Round**  
6 mm solid handle  
6 mm pełny uchwyt

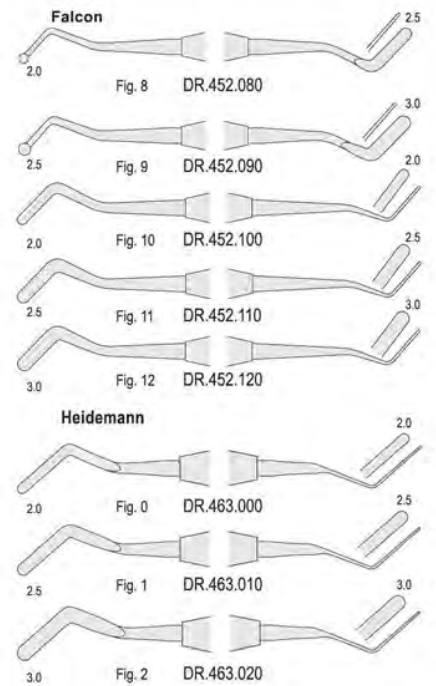
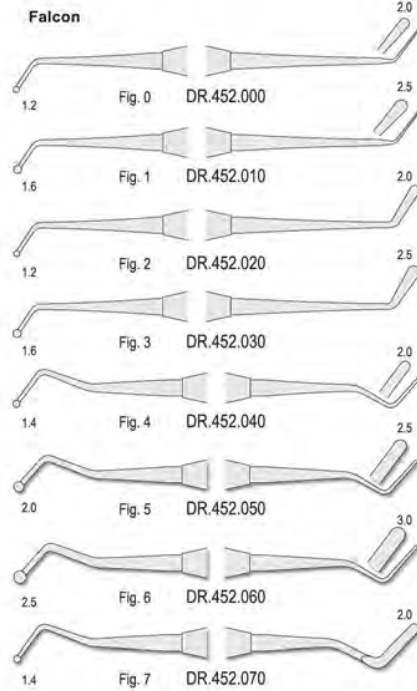
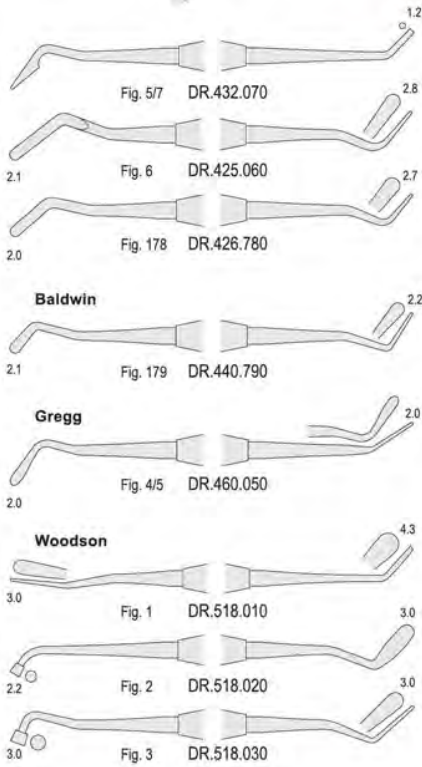

Cement spatulae  
Łopatki do cementu

**SOFT LINE INSTRUMENTS**  
soft and sure grip

135° C Autoclavable  
Możliwość sterylizacji w autoklawie



Cement spatulae  
Łopatki do cementu

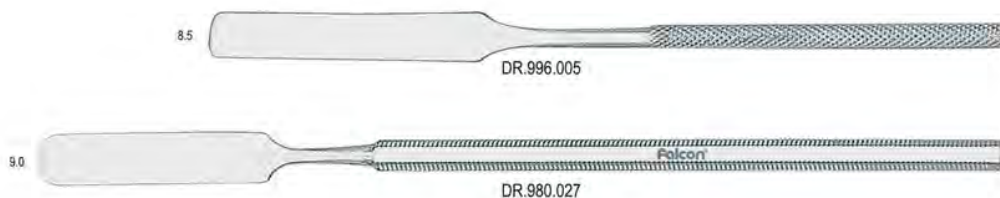



# Restorative Stomatologia zachowawcza

## Cement spatulae Łopatki do cementu

**Classic Round**  
6 mm solid handle  
6 mm pełny uchwyt



## Cement spatulae Łopatki do cementu

**Classic 8**  
5.5 mm solid handle  
5.5 mm pełny uchwyt



## Glass slabs Płytki do cementu



A mm	B mm	C mm	Code Kod
95	70	5	DR.998.010
120	80	5	DR.998.020
150	80	12	DR.998.030

## Mixing pads Bloczki papierowe do mieszania



**DENTALINE®**

DZ.458.010	50 x 50 mm
DZ.458.020	75 x 75 mm
DZ.458.030	75 x 125 mm
DZ.458.040	100 x 140 mm
DZ.458.050	140 x 180 mm

## Excavators Wydrążacze / Ekskawatory

**SOFT LINE INSTRUMENTS**  
soft and sure grip



135°C Autoclavable  
Możliwość sterylizacji w autoklawie

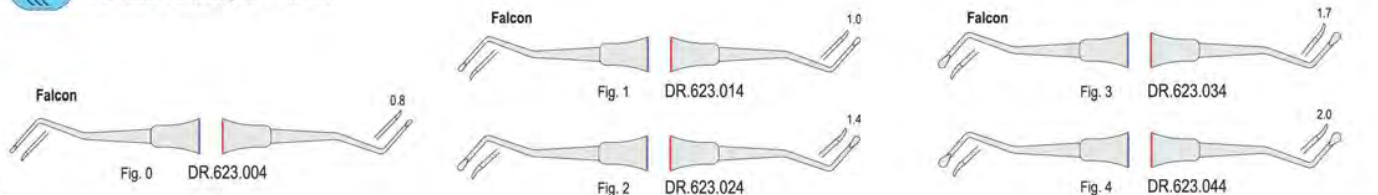

**Excavators**  
Wydrążacze / Ekskawatory

**Classic Round**  
6 mm solid handle  
6 mm pełny uchwyt

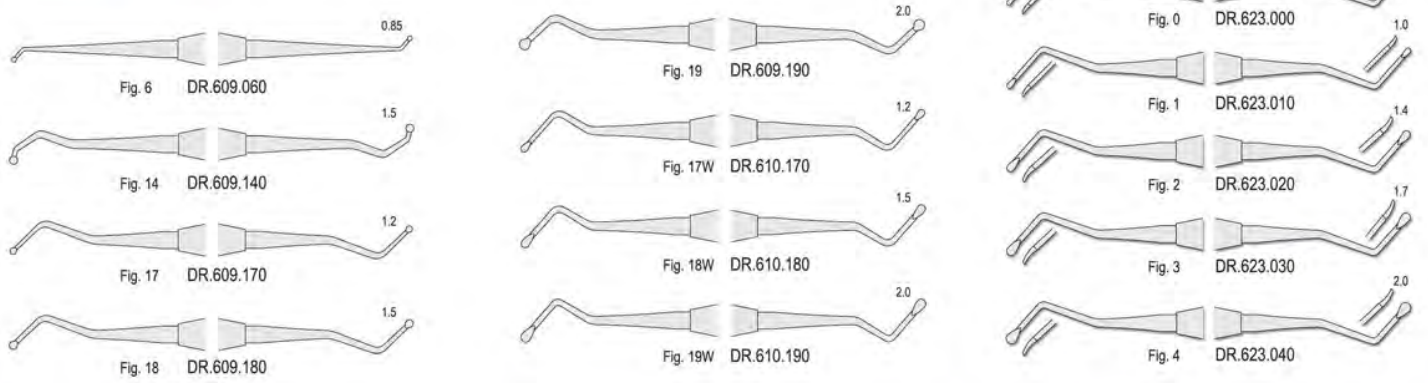

**Excavators**  
Wydrążacze / Ekskawatory

**Classic-8**  
5.5 mm solid handle  
5.5 mm pełny uchwyt

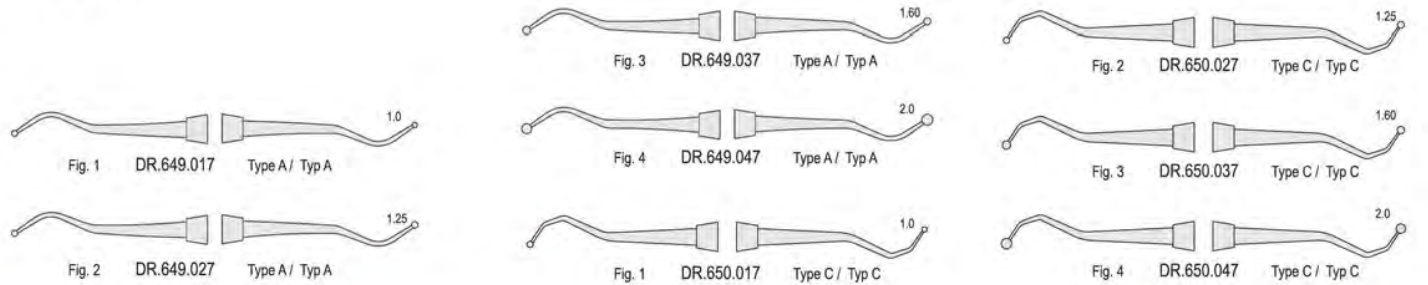

**Finishing knives**  
Nożyki do modelowania kompozytu

 135° C  
Autoclavable  
Możliwość sterylizacji w autoklawie

**SOFT LINE INSTRUMENTS**  
soft and sure grip

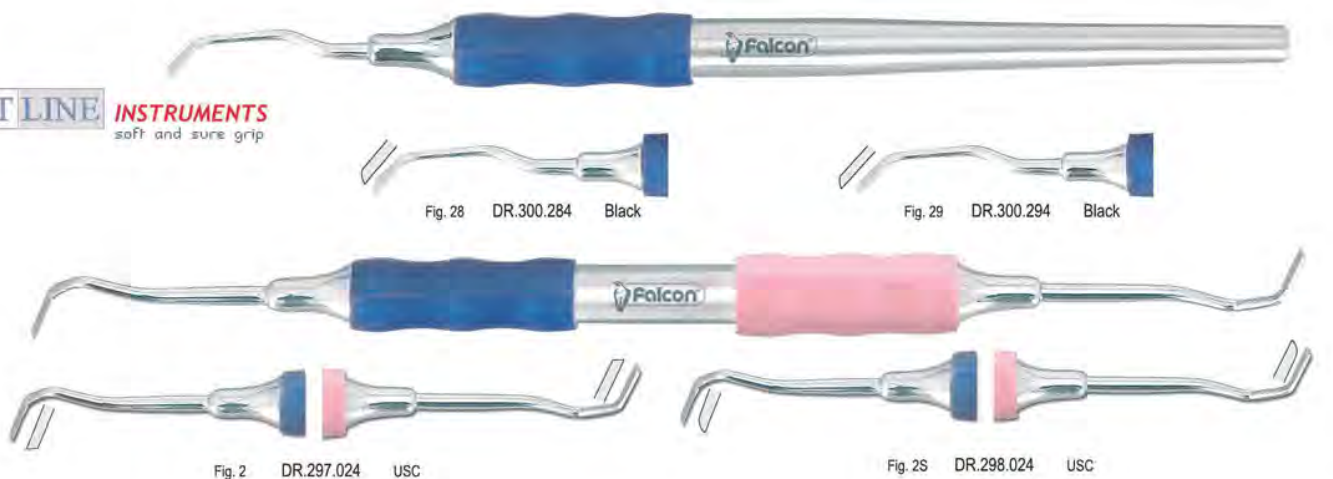



**Cavity preparation instruments  
Wydrążacze / Ekskawatory**



**Classic Round**

6 mm solid handle  
6 mm pełny uchwyt

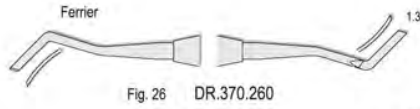
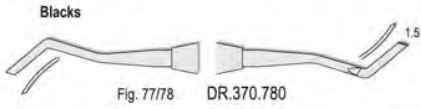

**Carvers  
Nożyki do modelowania**



**Classic Round**

6 mm solid handle  
6 mm pełny uchwyt

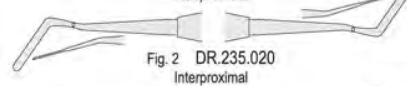
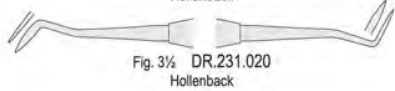
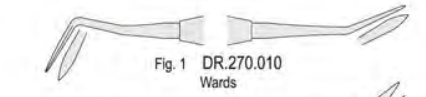
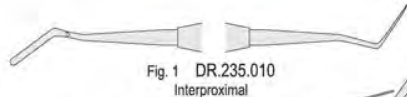

**Carvers  
Nożyki do modelowania**



**SOFT LINE INSTRUMENTS**  
soft and sure grip



Fig. 3 DR.230.034 Hollenback



Fig. 3½ DR.231.024 Hollenback

**Finishing knives / Nożyki do modelowania kompozytu**



Fig. 6T DR.296.065 Tanner

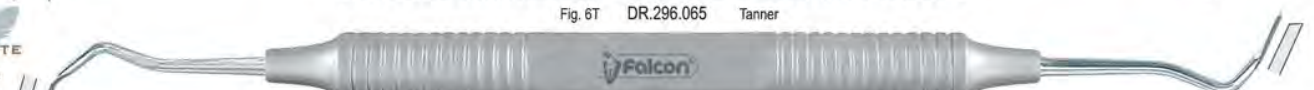

Fig. 2 DR.297.025 USC

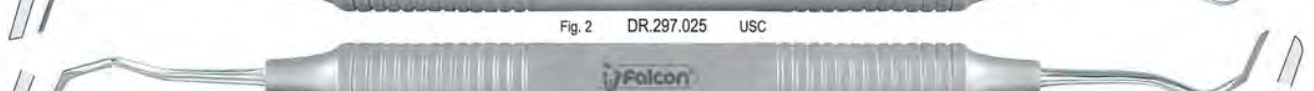

Fig. 2S DR.298.025 USC

**Cleoid-Discoid  
Cleoid-Discoid**



**Classic Round**

6 mm solid handle  
6 mm pełny uchwyt

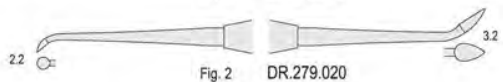
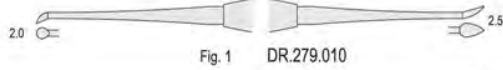



Cleoid-Discoïd  
Cleoid-Discoïd

**SOFT LINE INSTRUMENTS**  
soft and sure grip



Autoclavable  
Możliwość sterylizacji w autoklawie



Filling removing instrument  
Instrument do usuwania wypełnienia



Applicators for calcium hydroxide  
Aplikatory do dycal



Applicator for medicaments  
Aplikator do leków



Serie-UNO  
Economical dental instruments  
Instrumenty stomatologiczne w atrakcyjnej cenie



Autoclavable  
Możliwość sterylizacji w autoklawie



Pluggers / Przenośniki



Burnishers / Upychadła





**Serie-UNO**

**Economical dental instruments**

**Instrumenty stomatologiczne w atrakcyjnej cenie**



Autoclavable  
Możliwość sterylizacji w autoklawie



**Filling instruments / Nakładacze**

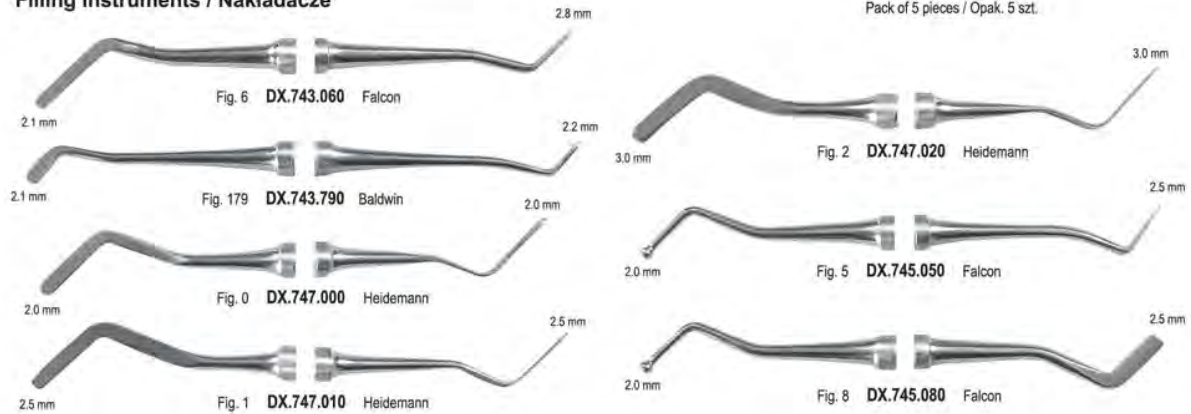

**Cement spatula / Łopátka do cementu**



**Automatic crown and bridge remover  
Zbijak do koron samopowtarzalny**

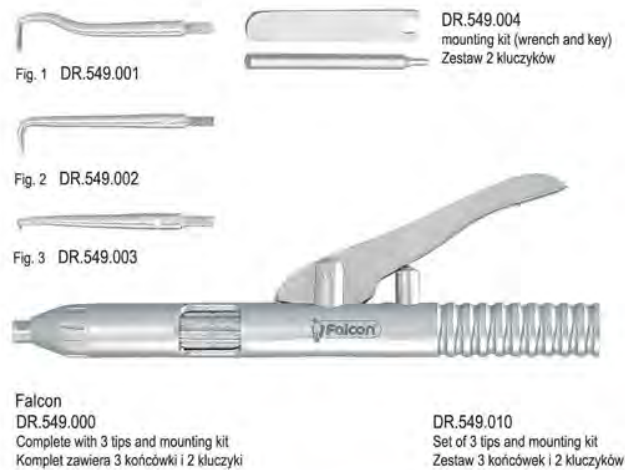

**Semi-automatic crown and bridge remover  
Zbijak do koron trzystopniowy**



**Manual crown remover double ended  
Zbijak do koron ręczny dwustronny**



**Manual crown remover  
Zbijak do koron ręczny**





**Manual crown remover**  
Zbijak do koron ręczny



Fig. 1 DR.559.001

Fig. 2 DR.559.002

Fig. 3 DR.559.003

Morrel  
DR.559.000  
Complete with 3 tips  
Komplet zawiera 3 końcówki

DR.559.010  
Set of 3 tips  
Zestaw 3 końcówek

**Manual crown remover with spring**  
Zbijak do koron ręczny ze sprężyną



Fig. 1 DR.559.001

Fig. 2 DR.559.002

Fig. 3 DR.559.003

Morrel  
DR.560.000  
Complete with 3 tips  
Komplet zawiera 3 końcówki

DR.560.010  
Set of 3 tips  
Zestaw 3 końcówek

**Manual crown remover double ended**  
Zbijak do koron ręczny dwustronny



Fig. 1 DR.554.001

Fig. 2 DR.554.002

Fig. 3 DR.554.003

Falcon  
DR.554.000  
Complete with 3 tips  
Komplet zawiera 3 końcówki

DR.554.010  
Set of 3 tips  
Zestaw 3 końcówek

**Crown pliers**  
Kleszcze do koron



DR.531.160  
Wynman-Falcon  
160 mm  
With Tungsten Carbide inserts  
z wkładką z węgliką spiekanego



DR.532.160  
Wynman-Falcon  
160 mm  
With Tungsten Carbide inserts  
z wkładką z węgliką spiekanego

**Temporary crown removing pliers**  
Kleszcze do zdejmowania tymczasowe koron



DR.535.010  
Set of 10 tips  
Zestaw 10 końcówek

DR.535.000  
155mm  
Complete with 10 tips  
Komplet zawiera 10 końcówek



DR.539.010  
Furrer  
160 mm



**Restorative  
Stomatologia zachowawcza**

**Crown spreaders  
Rozwieracze do koron**



DR.570.000  
Falcon



Fig. 3 DR.571.030



Fig. 0 DR.571.000



Fig. 1 DR.571.010



Fig. 2 DR.571.020

**Crown spreaders  
Rozwieracze do koron**



DR.571.010  
Falcon  
145mm

**Manual crown remover / Crown spreaders  
Rozwieracze do koron**



DR.572.000  
Complete with 6 tips  
Komplet zawiera 6 końcówki

**Forceps for articulating paper  
Pensety do kalki**



DR.700.010  
Miller  
150 mm



DR.700.020  
Miller  
150 mm



DR.698.010  
Falcon  
150 mm



DR.699.010  
Falcon  
Full arch / Pełny łuk

**Contoured anatomical matrices**  
**Paseki anatomiczne do formówek**

Pack of 30 pieces / Opak. 30 sztuk  
Grubość 0.05 mm



**DR.811.010**  
Premolars left  
Przedtrzonowce lewe



**DR.811.020**  
Premolars right  
Przedtrzonowce prawe



**DR.811.030**  
Molars left  
Trzonowce lewe



**DR.811.040**  
Molars right  
Trzonowce prawe



**DR.811.050**  
Premolars left, right  
Przedtrzonowce obustronne



**DR.811.060**  
Molars left, right  
Trzonowce obustronne



**DR.811.000**  
Assorted  
Asortyment

**Matrix bands**  
**Paski do formówek**

Thickness / Grubość  
0.04 mm



DR.799.050 5 mm  
DR.799.060 6 mm  
DR.799.070 7 mm  
Length / Długość 10 m

Thickness / Grubość  
0.05 mm



DR.800.050 5 mm  
DR.800.060 6 mm  
DR.800.070 7 mm  
Length / Długość 10 m

Ivory  
Pack of 12 pieces  
Opak. zawiera 12 szt.



Fig. 11 DR.806.010  
for children / dziecięce



Fig. 12 DR.806.020  
for children / dziecięce



Fig. 14 DR.805.010  
small / małe



Fig. 15 DR.805.020  
medium / średnie



Fig. 16 DR.805.030  
large / duże

Nyström  
Pack of 12 pieces  
Opak. zawiera 12 szt.



Fig. 2 DR.808.020  
premolars / przedtrzonowce



Fig. 4 DR.808.040  
molars / trzonowce



Fig. 5 DR.808.050  
molars / trzonowce



Fig. 6 DR.808.060  
premolars / przedtrzonowce



Fig. 7 DR.808.070  
molars / trzonowce

Tofflemire  
Pack of 12 pieces  
Opak. zawiera 12 szt.



Fig. 101 DR.810.101



Fig. 102 DR.810.102

**Polyester matrix band**  
**Taśma poliesterowa gładka**



DR.1100.50 8mm x 0.05mm  
DR.1100.80 8mm x 0.75mm

15 mb ± 5 cm Length / Długość



**Matrix retainers**  
**Formówki**



5 mm  
DR.829.050  
Falcon



DR.840.010  
Tofflemire-Junior



5 mm  
DR.830.085  
Ivory



DR.840.020  
Tofflemire-Senior



Fig. 12  
DR.830.120  
Ivory



6 mm  
DR.830.086  
Ivory



DR.840.030  
Tofflemire-Universal



7 mm  
DR.830.087  
Ivory



Left / Lewa  
DR.832.010  
Nyström



DR.855.010  
Matrix clamp  
Zacisk do pasków



Fig. 12A  
DR.830.121  
Ivory



Right / Prawa  
DR.832.020  
Nyström

**Matrix forceps**  
**Kleszcze do formówek pierścieniowych**



Falcon  
DR.820.170  
170 mm

**Latex rubber dam  
Koferdam z lateksu**



Green / Zielony  
150 x 150 mm  
36 sheets / 36 szt.

DR.899.010  
0.14  
Thin / Cienki

DR.899.020  
0.18  
Medium / O średniej grubości

DR.899.030  
0.22  
Heavy / Gruby

**Rubber dam clamps  
Klamry do koferdamu**

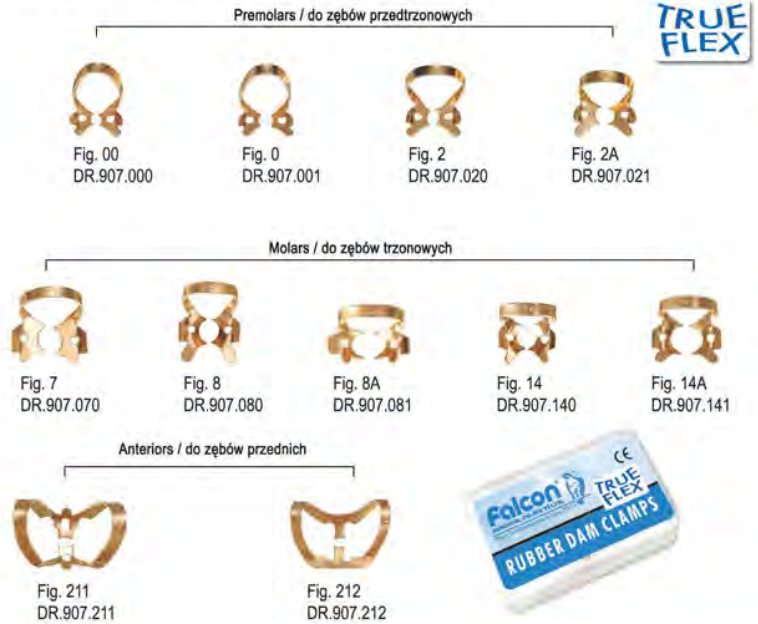

**Rubber dam clamps  
Klamry do koferdamu**



Fig. A  
DR.905.001  
Molars  
do zębów trzonowych



Fig. AW  
DR.905.002  
Molars  
do zębów trzonowych



Fig. BW  
DR.905.003  
Molars  
do zębów trzonowych



Fig. C  
DR.905.004  
Incisors, canines and premolars  
do zębów przednich i przedtrzonowych



Fig. DW  
DR.905.005  
Molars  
do zębów trzonowych



Fig. E  
DR.905.006  
Incisors, canines and premolars  
do zębów przednich i przedtrzonowych



Fig. EW  
DR.905.007



Fig. FW  
DR.905.008  
Molars  
do zębów trzonowych



Fig. G  
DR.905.009  
Molars  
do zębów trzonowych



Fig. GW  
DR.905.010  
Molars  
do zębów trzonowych



Fig. HW  
DR.905.011  
Molars  
do zębów trzonowych



Fig. JW  
DR.905.012  
Molars  
do zębów trzonowych



Fig. K  
DR.905.013  
Molars  
do zębów trzonowych



Fig. L  
DR.905.014  
Incisors, canines and premolars  
do zębów przednich i przedtrzonowych



Fig. M  
DR.905.015  
Incisors, canines and premolars  
do zębów przednich i przedtrzonowych



Fig. NW  
DR.905.016  
Molars  
do zębów trzonowych



Fig. PW  
DR.905.017  
Molars  
do zębów trzonowych

**Premolars / do zębów przedtrzonowych**



Fig. 00  
DR.906.100



Fig. 0  
DR.906.110



Fig. 1  
DR.906.120



Fig. 2  
DR.906.130



Fig. 2A  
DR.906.140

**Anteriors / do zębów przednich**



Fig. 9  
DR.906.090



Fig. 212  
DR.906.212

**Molars / do zębów trzonowych**



Fig. 7  
DR.906.530



Fig. 8  
DR.906.550



Fig. 8A  
DR.906.560



Fig. 14  
DR.906.590



Fig. 14A  
DR.906.600



## Restorative Stomatologia zachowawcza

### Rubber dam clamps tray Tacka na klamry



DR.904.010  
Falcon

### Rubber dam template Szablon do koferdamu

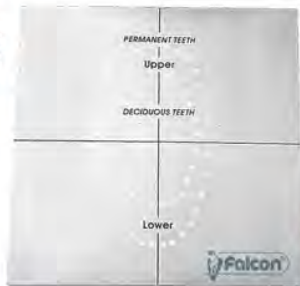

DR.948.000



Autoclavable  
Możliwość sterylizacji w autoklawie

### Anatomical plastic rubber dam frame Ramka do koferdamu anatomiczna, plastikowa



Autoclavable  
Możliwość sterylizacji w autoklawie



DR.937.020  
For adult / Dla dorosłych

DR.937.030  
For child / Dla dzieci

### Rubber dam frames Ramki do koferdamu



Autoclavable  
Możliwość sterylizacji w autoklawie



DR.938.130 130 mm  
Young

DR.938.150 150 mm  
Young

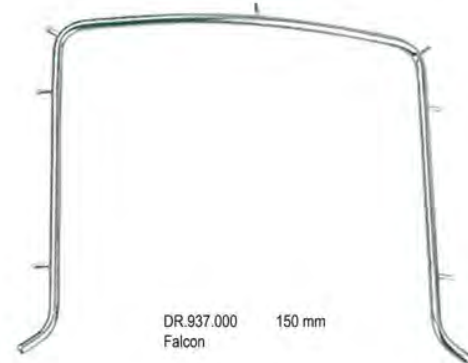

DR.937.000 150 mm  
Falcon

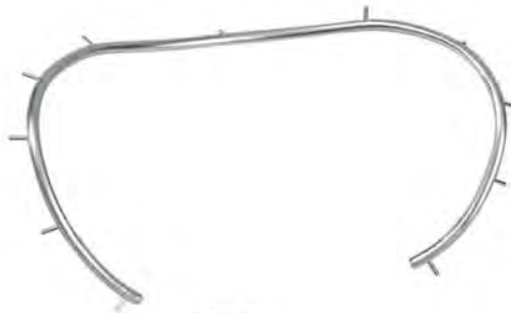

DR.937.010  
Falcon

### Plastic flexible rubber dam frame Ramka do koferdamu plastikowa



Autoclavable  
Możliwość sterylizacji w autoklawie



DR.937.040  
For child / dla dzieci 98 x 74mm  
DR.937.050  
For adult / dla dorosłych, 148 x 102mm

### Plastic rubber dam frames Ramka do koferdamu plastikowa



Autoclavable  
Możliwość sterylizacji w autoklawie



DR.937.060 85 x 105mm  
Young

Rubber dam clamp forceps  
Kleszce do klamer do koferdamu



Autoclavable  
Możliwość sterylizacji w autoklawie

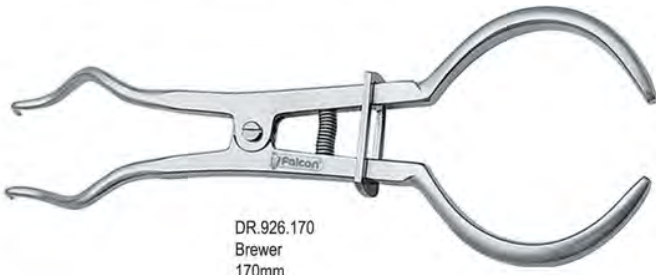

DR.926.170  
Brewer  
170mm



DR.928.170  
IV  
170mm



DR.929.170  
Falcon  
170mm



DR.931.170  
Stokes  
170mm



DR.932.170  
Stokes/Palmer  
170mm

Rubber dam punches  
Dziurkacze do koferdamu



Autoclavable  
Możliwość sterylizacji w autoklawie



DR.940.160  
Ainsworth  
160mm



DR.946.160  
IV  
160mm



**Rubber dam instrument sets / Zestawy do koferdamu**



Autoclavable  
Możliwość sterylizacji w autoklawie

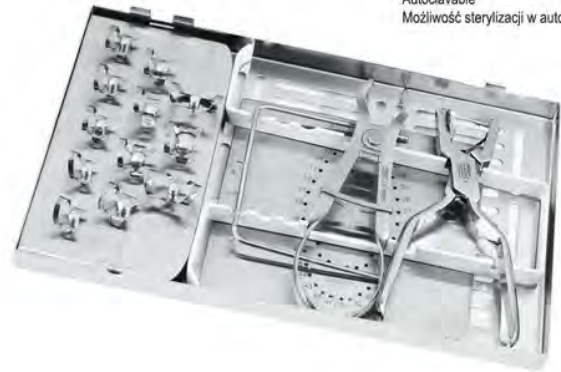

**DR.900.009**  
Contents/ Zawiera :

Rubber dam clamps  
Klamry do koferdamu

**Premolars / do zębów przedtrzonowych**



Fig. 00  
DR.906.100



Fig. 0  
DR.906.110



Fig. 1  
DR.906.120



Fig. 2  
DR.906.130



Fig. 2A  
DR.906.140

**Anteriors / do zębów przednich**



Fig. 9  
DR.906.090



Fig. 212  
DR.906.212

**Molars / do zębów trzonowych**



Fig. 7  
DR.906.530



Fig. 8  
DR.906.550



Fig. 8A  
DR.906.560



Fig. 14  
DR.906.590



Fig. 14A  
DR.906.600

Rubber dam clamps tray  
Tacka na klamry



DR.904.010  
Falcon

Rubber dam frames  
Ramki do koferdamu



DR.938.130 130 mm  
Young

Rubber dam clamp forceps  
Kleszce do klamer do koferdamu



DR.928.170  
IV  
170mm

Rubber dam punches  
Dziurkacz do koferdamu



DR.940.160  
Ainsworth  
160mm

Rubber dam template  
Szablon do koferdamu

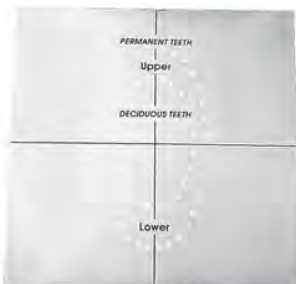

DR.948.000

Latex rubber dam  
Koferdam z lateksu



DR.899.020  
0.18  
Medium / 0 średniej grubości

Green / Zielony  
150 x 150 mm  
36 sheets / 36 szt.

Sterilization cassettes / Kasetki do sterylizacji z zamkiem  
Suitable for ultrasonic baths, disinfectors, autoclaves  
Pasują do myjek ultradźwiękowych, dezynfektorów, autoklawów.



DZ.086.030  
288 x 182x 34 mm





Rubber dam instrument sets / Zestawy do koferdamu



DR.900.006  
Contents/ Zawiera :



Autoclavable  
Możliwość sterylizacji w autoklawie

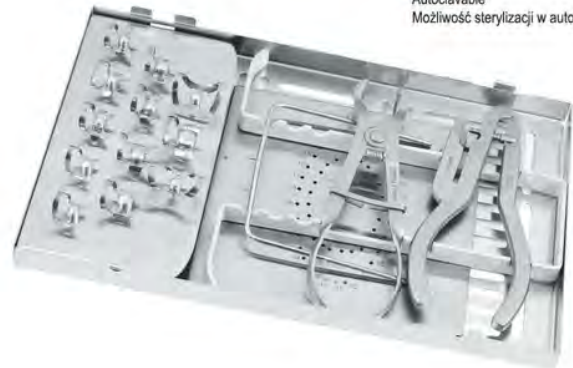

Rubber dam clamps  
Klamry do koferdamu

Premolars / do zębów przedtrzonowych



Fig. 00  
DR.906.100



Fig. 0  
DR.906.110



Fig. 1  
DR.906.120



Fig. 2  
DR.906.130



Fig. 2A  
DR.906.140

Anteriors / do zębów przednich



Fig. 9  
DR.906.090



Fig. 212  
DR.906.212

Molars / do zębów trzonowych



Fig. 7  
DR.906.530



Fig. 8  
DR.906.550



Fig. 8A  
DR.906.560



Fig. 14  
DR.906.590



Fig. 14A  
DR.906.600

Rubber dam clamps tray  
Tacka na klamry



DR.904.010  
Falcon

Rubber dam frames  
Ramki do koferdamu



DR.938.130 130 mm  
Young

Rubber dam clamp forceps  
Kleszce do klamer do koferdamu



DR.928.170  
IV  
170mm

Rubber dam punches  
Dziurkacze do koferdamu

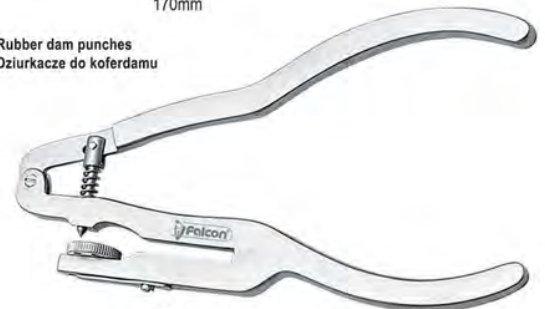

DR.946.160  
IV  
160mm

Rubber dam template  
Szablon do koferdamu

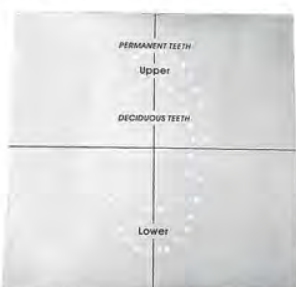

DR.948.000

Latex rubber dam  
Koferdam z lateksu



DR.899.020  
0.18  
Medium / O średniej grubości

Green / Zielony  
150 x 150 mm  
36 sheets / 36 szt.

Sterilization cassettes / Kasetki do sterylizacji z zamkiem

Suitable for ultrasonic baths, disinfectors, autoclaves  
Pasują do myjek ultradźwiękowych, dezynfektorów, autoklawów.



DZ.086.030  
288 x 182x 34 mm



**Rubber dam instrument sets / Zestawy do koferdamu**



Autoclavable  
Możliwość sterylizacji w autoklawie



**DR.900.007**  
Contents/ Zawiera :

**Rubber dam clamps  
Klamry do koferdamu**



**Fig. A**  
**DR.905.001**  
Molars  
do zębów trzonowych



**Fig. C**  
**DR.905.004**  
Incisors, canines and premolars  
do zębów przednich i przedtrzonowych



**Fig. E**  
**DR.905.006**  
Incisors, canines and premolars  
do zębów przednich i przedtrzonowych



**Fig. FW**  
**DR.905.008**  
Molars  
do zębów trzonowych



**Fig. G**  
**DR.905.009**  
Molars  
do zębów trzonowych



**Fig. K**  
**DR.905.013**  
Molars  
do zębów trzonowych



**Fig. L**  
**DR.905.014**  
Incisors, canines and premolars  
do zębów przednich i przedtrzonowych



**Fig. M**  
**DR.905.015**  
Incisors, canines and premolars  
do zębów przednich i przedtrzonowych

**Rubber dam clamps tray  
Tacka na klamry**



**DR.904.010**  
Falcon

**Rubber dam frames  
Ramki do koferdamu**



**DR.938.130** 130 mm  
Young

**Rubber dam clamp forceps  
Kleszce do klamer do koferdamu**



**DR.926.170**  
Brewer  
170mm

**Rubber dam punches  
Dziurkaczki do koferdamu**



**DR.940.160**  
Ainsworth  
160mm

**Rubber dam template  
Szablon do koferdamu**

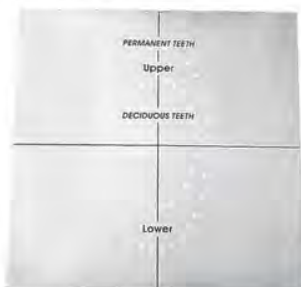

**DR.948.000**

**Latex rubber dam  
Koferdam z lateksu**



**DR.899.020**  
0.18  
Medium / O średniej grubości

Green / Zielony  
150 x 150 mm  
36 sheets / 36 szt.

**Sterilization cassettes / Kasetki do sterylizacji z zamkiem**  
Suitable for ultrasonic baths, disinfectors, autoclaves  
Pasują do myjek ultradźwiękowych, dezynfektorów, autoklawów.



**DZ.086.030**  
288 x 182x 34 mm



#### **Biuro i Magazyn**

**Falcon Medical Polska sp z o.o.**  
93-575 Łódź, ul. Rembielińskiego 1/7  
Poland  
Tel: +48 42 630 99 72  
Fax: +48 42 630 99 73  
[www.falconmedical.pl](http://www.falconmedical.pl)

#### **Sklep firmowy**

**Sklep Stomatologiczno Medyczny**  
Al. Kościuszki 32, 90-419 Łódź  
Poland  
Tel: +48 42 632 20 01  
Fax: +48 42 632 20 01